

EVORICH® Decks



*evoDECK Walnut Grove Design
Swimming Pool*



*evoDECK Walnut Grove Design
Sentosa Fire Station*



splashDECK - Ideal for HDB Balconies Only



*evoDECK Walnut Grove Design
Singapore Changi Airport Terminal 3 - Smoking Area*



*evoDECK - tough enough
for Public Pavement*



GREEN STORY

evoDECK adds realistic wood appearance to residential and commercial premises because of its consistent and long lasting quality and its vibrant colours. The highly dense material gives absolute strength and durability.

SUITS LIFESTYLE NEEDS



evoDECK is suitable to install at many areas such as balcony, swimming pool decking, planter box patio etc. It brings you and your family closer to the environment with its simple and elegant natural look.

ENVIRONMENTAL FRIENDLY

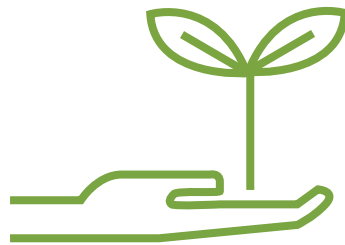

It is made of 95% recycled materials such as reclaimed wood fibers. This anti-hazardous move saves tons of plastic waste. Due to its capped composite materials, it also keeps your family away from harmful chemical.



Realistic
wood embossing

Does not crack
and splinter-free

High stain-resistance
technology

Withstands harsh
weather conditions

Can manage high
human traffic

DECKING

evoDECK comes in solid profiles for commercial and residential applications. It is wrapped in 360 degrees including grooves. Our guard polymer provides protection against moisture, mold and mildew.

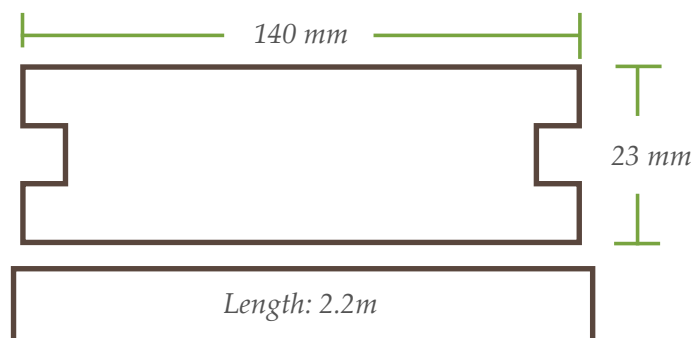

STAINS

Wine, coffee, soy sauce and vegetable oil etc cannot stain the board. Messes can be easily wiped off the surface because the liquid never gets absorbed by the guard polymer, which makes evoDECK easy to clean and requires low maintenance.

MILDEW, MOLD, ROTTING, SPLITTING OR CRACKING

The guard polymer provides an impermeable layer, so there is no fungus growth to occur on the surface of the board, therefore, giving evoDECK a longer life span than regular, uncapped composites.

COLOUR FADING

The unique formulation of the shield ensures its colour stays much longer compared to conventional composite decking. The result of 3000 hours in a QUV accelerated weathering test chamber is Delta E<4.0, meaning no visible colour change can be observed by the human eye.

PAINTING OR OILING

The multichromatic colours are a part of the guard polymer formulation meaning that you will never have to paint, sand or oil again.

High Protection & Low Maintenance

evoDECK



Other WPC

50mm by 50mm treated (anti-micro organism deterrence) baton.

Uses stainless steel clips with stainless steel screws.

Possesses realistic embossed wood grains.

Homogenous SOLID core.

50mm by 25mm non-treated (prone to termites attack).

Uses plastic clips with mix alloy screws.

Having real plastic look.

Mostly having hollow honey comb structure.

Manufactured by small OEM factories in China with no proven track record.

Technical Components

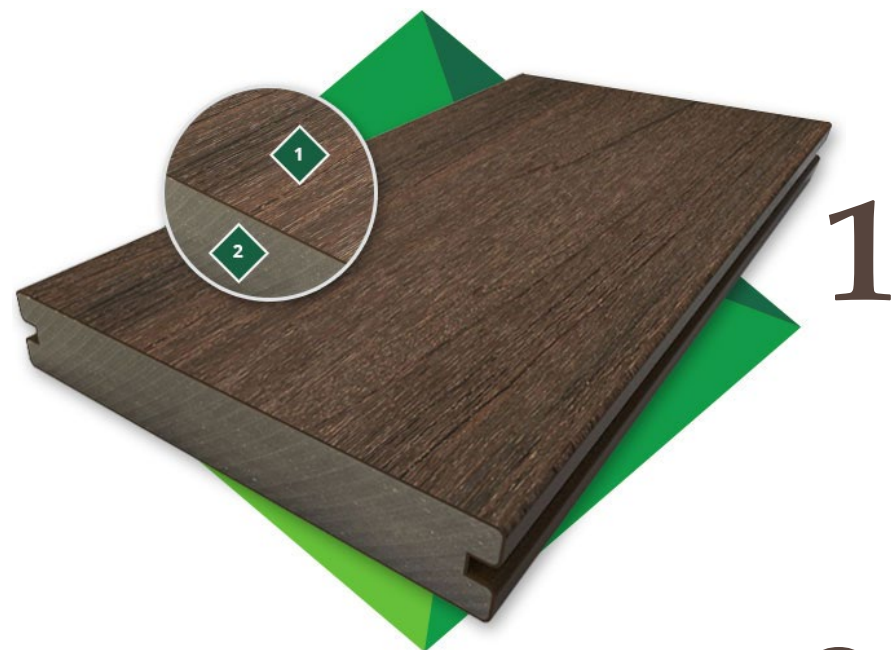

POLYMER GUARD WEAR LAYER

- Polymer Guard's Patented formula provides color striking and deep wood grains that bring you warmth and beauty of wood without the maintenance.
- The wear layer withstands high traffic without exhibiting signs of wear and tear as seen in conventional composite wood.
- It encases all four sides to give absolute protection from Mother Nature's harshest condition

2

CORE

- evoDECK's light core allows for little expansion and contraction and easier handling.
- The core uses coarse wood fibers for greater strength and durability.

	evoDECK	Normal WPC	Natural / Treated Wood
<i>Strength</i>			
<i>UV resistance</i>			
<i>Low electrical conductivity</i>			
<i>Save natural resources</i>			
<i>Environmental friendly</i>			
<i>High recycled material content</i>			
<i>Resistance to cracking</i>			
<i>Resistance to rotting</i>			
<i>Resistance to rusting</i>			
<i>Resistance to splintering</i>			
<i>Resistance to termite</i>			
<i>Resistance to weathering</i>			
<i>Low maintenance</i>			
<i>Durability</i>			
<i>Recoverability of dimensional stability</i>			
<i>Low Thermal conductivity</i>			



Result of *Common Outdoor Wood*

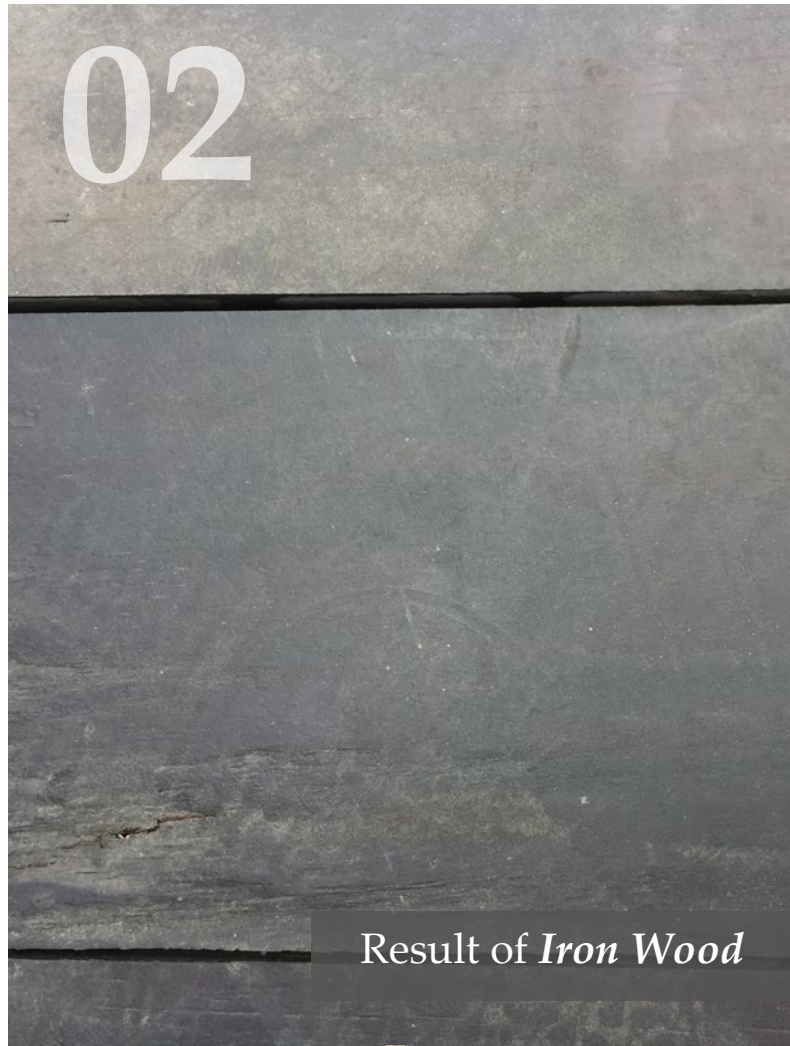

Result of *Iron Wood*

01

Rotting

Discolouration

02

Problems that occur with

WOOD DECKING

03

Result of *Young Chengal Wood*

04

Result of *Merbau Wood*

03

Termite Issues

Gapping & Popping Out

04



05

Result of *Chemically Treated Wood*

05

Cracking



06

Result of *Kapor Wood*

06

Splintering

evoDECK can be installed at:



Decking

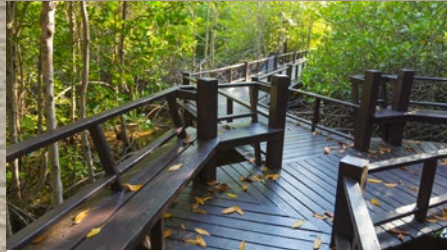

Boardwalks



Bridges



Viewing Platforms



Park Furniture



Screening



Signage



External Facade Claddings



Pergolas



Swimming Pool Sides



Post & Rail



Customized Projects



Code: #evoDECK CN016
Colour: Nautical Teak
Width: 140mm | Length: 2.2m
Thickness: 23mm

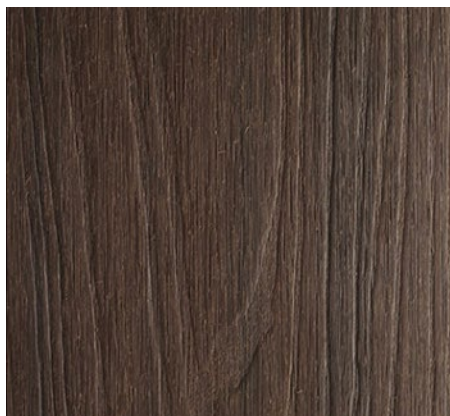

Code: #evoDECK CN004
Colour: Walnut Grove
Width: 140mm | Length: 2.2m
Thickness: 23mm



Code: #evoDECK CN031
Colour: Mystic Coal
Width: 140mm | Length: 2.2m
Thickness: 23mm

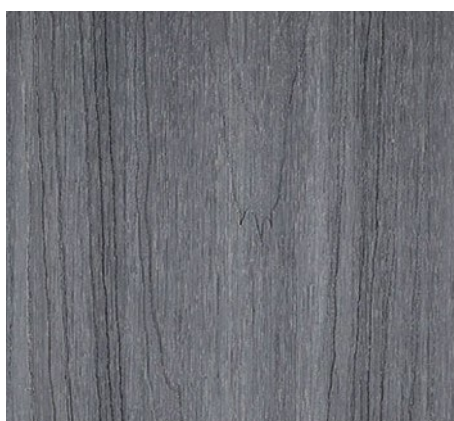

Code: #evoDECK CN019
Colour: Ash Grey
Width: 140mm | Length: 2.2m
Thickness: 23mm



Code: #evoDECK CN005
Colour: Raw Antique
Width: 140mm | Length: 2.2m
Thickness: 23mm

Commercial Projects in Singapore with evoDECK

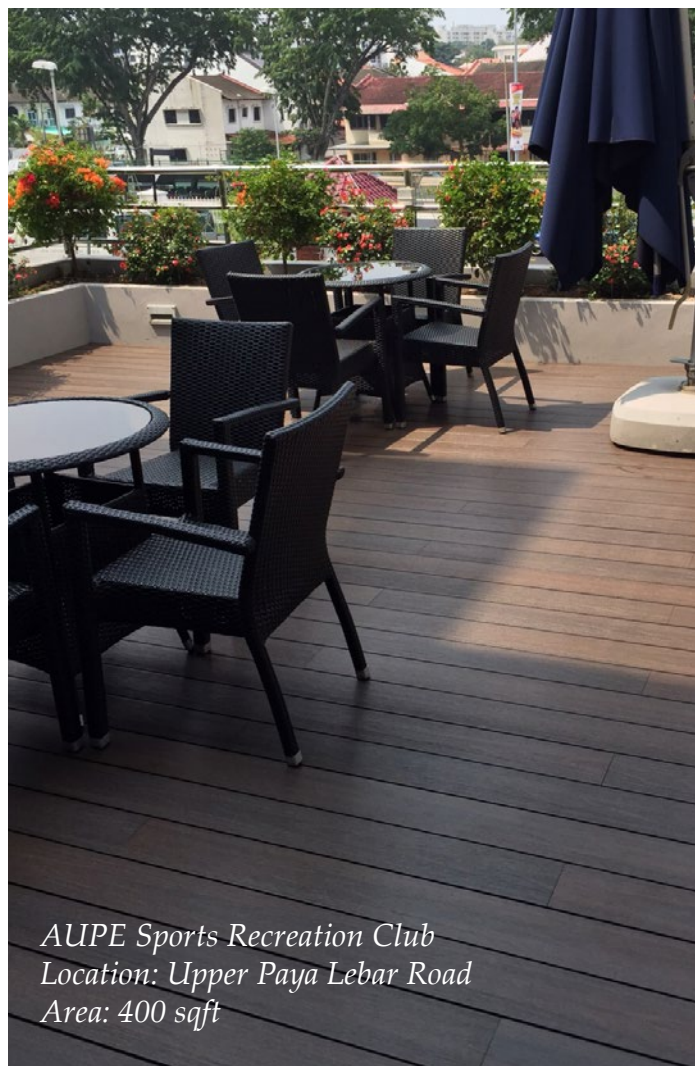
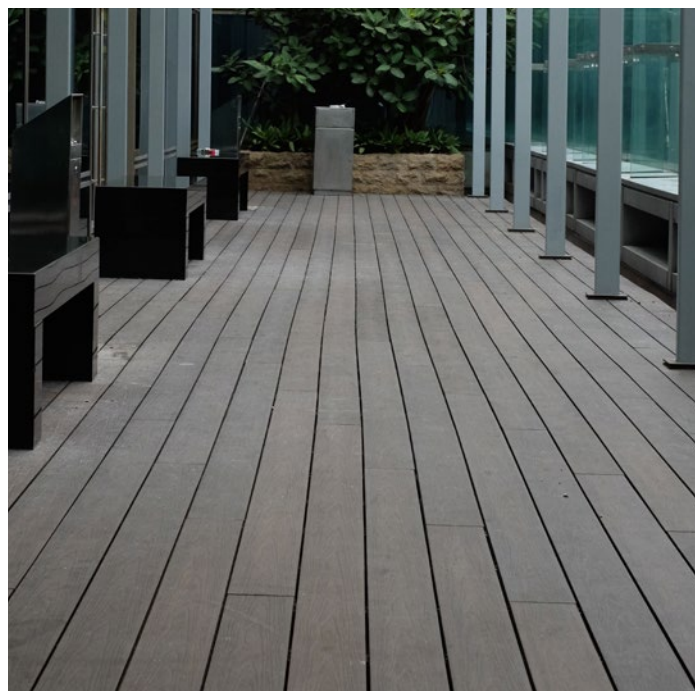
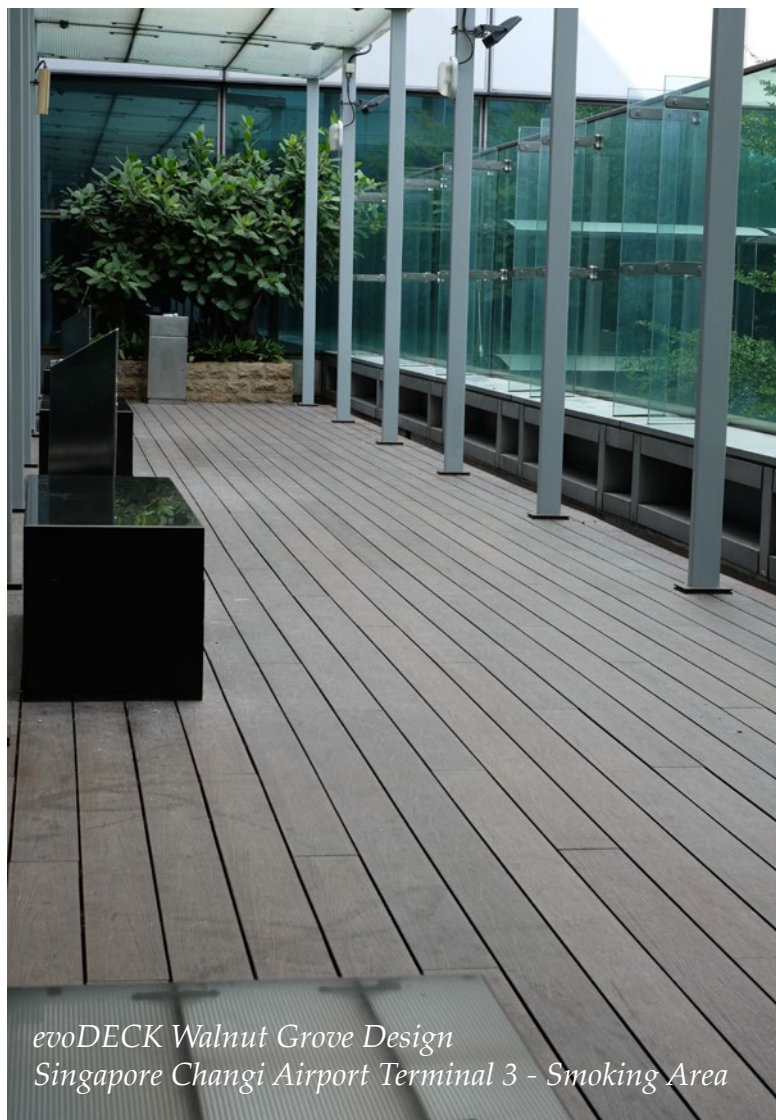

Commercial Projects in Singapore with evoDECK



*evoDECK - Walnut Grove
Resorts World Singapore*

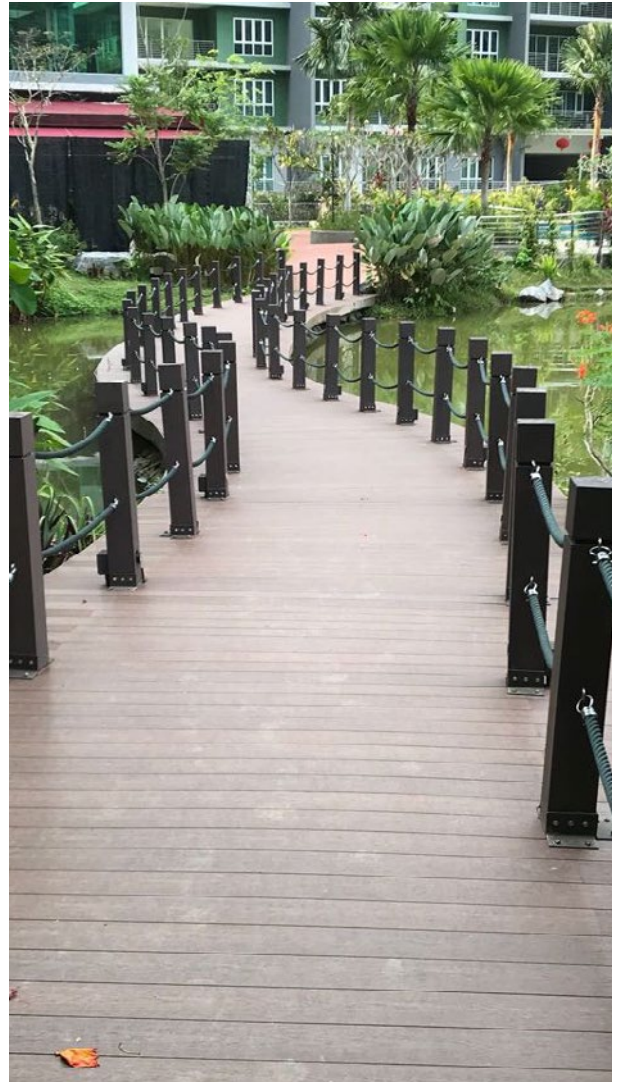

*Somewhere Only We Know Cafe, 85 Circular Rd,
Singapore 049437*

Recent Residential Projects in Singapore with evoDECK

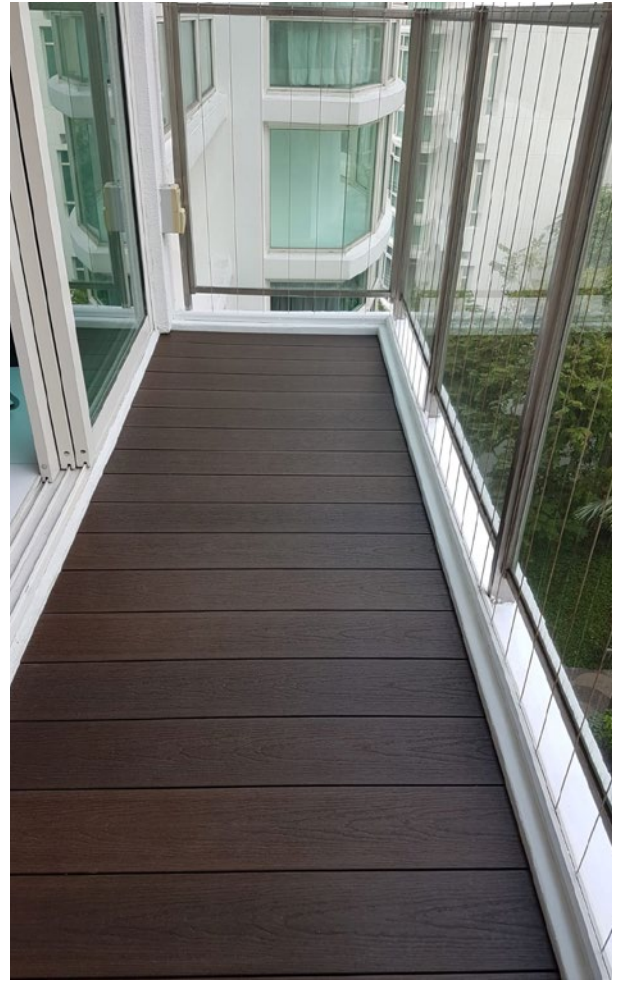

Recent Residential Projects in Singapore with evoDECK

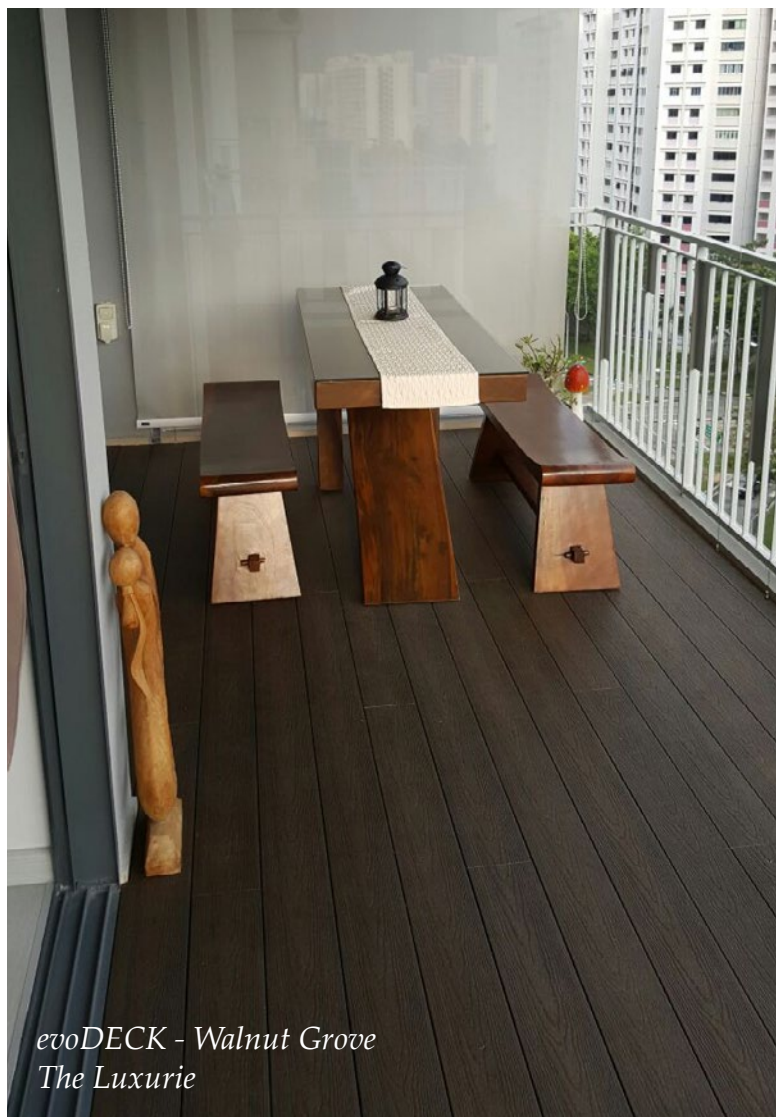

*evoDECK - Walnut Grove
The Luxurie*



*evoDECK - Walnut Grove
Lengkong Tujuh*

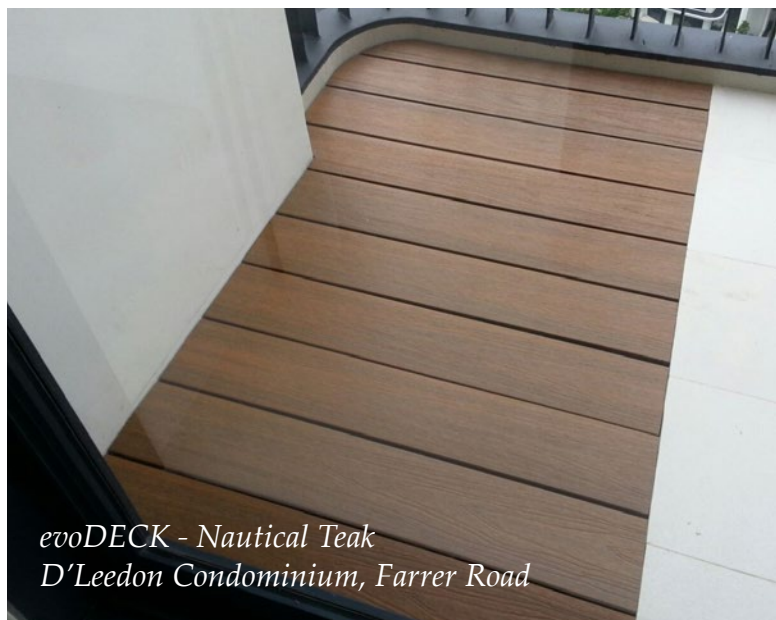

*evoDECK - Nautical Teak
D'Leedon Condominium, Farrer Road*

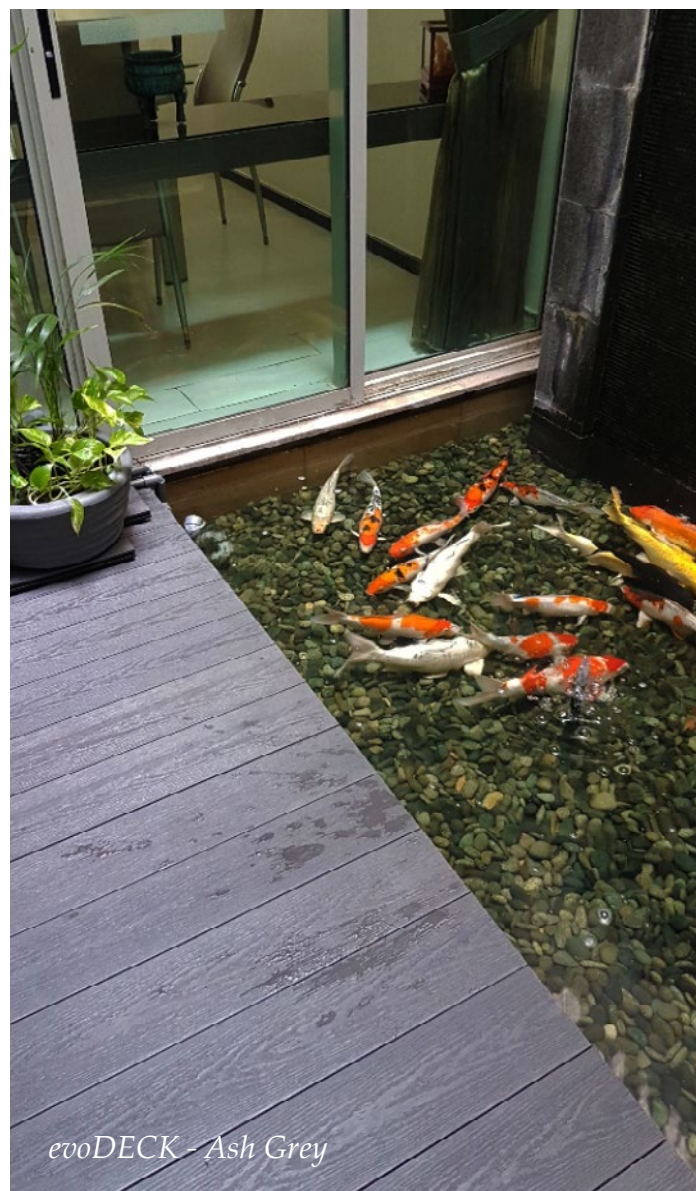

evoDECK - Ash Grey

Recent Residential Projects in Singapore with evoDECK

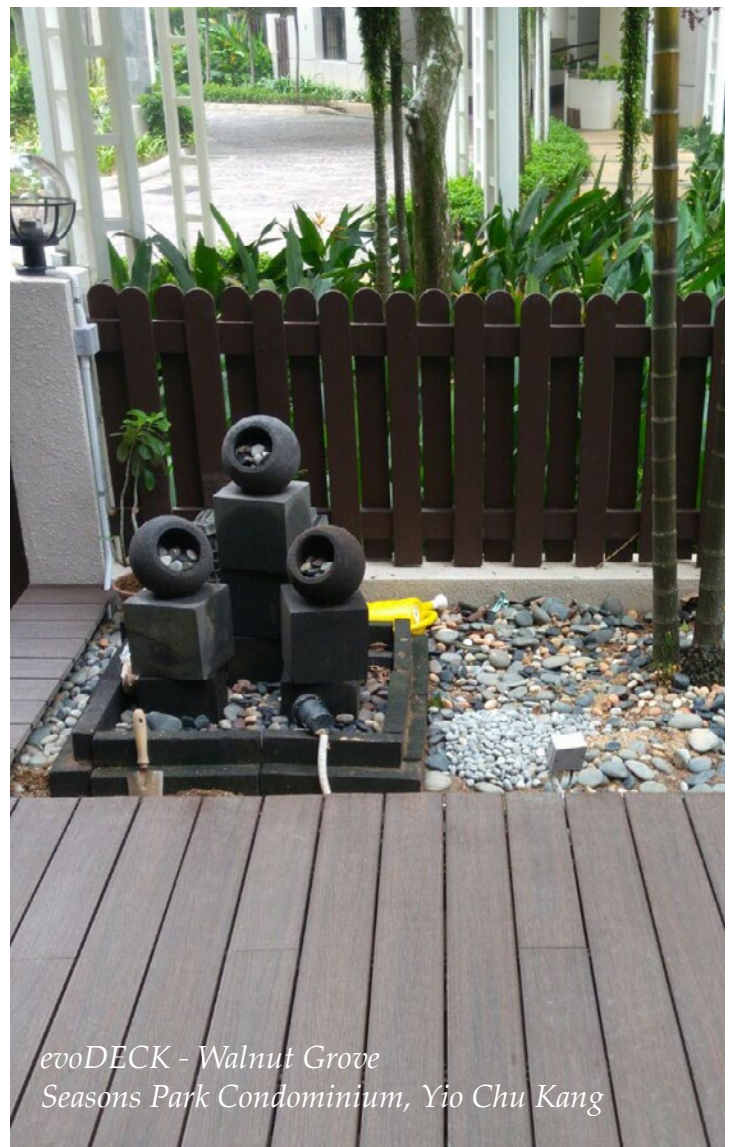

Recent Residential Projects in Singapore with evoDECK



*evoDECK - Walnut Grove
Mt. Sinai*



evoDECK - Walnut Grove



*evoDECK - Walnut Grove
The Luxurie Condominium , Sengkang*



evoDECK - Nautical Teak

Recent Residential Projects in Singapore with evoDECK

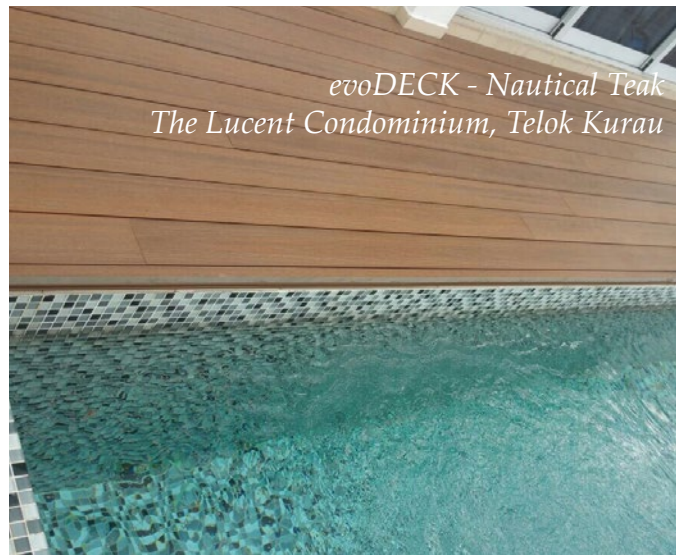
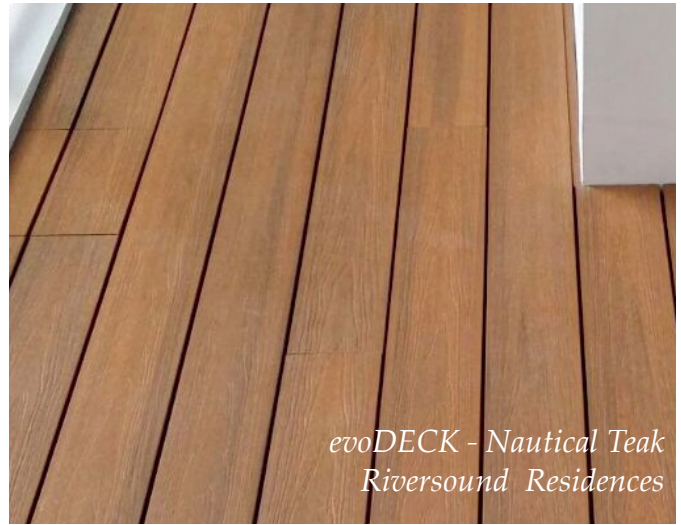

Recent Residential Projects in Singapore with evoDECK

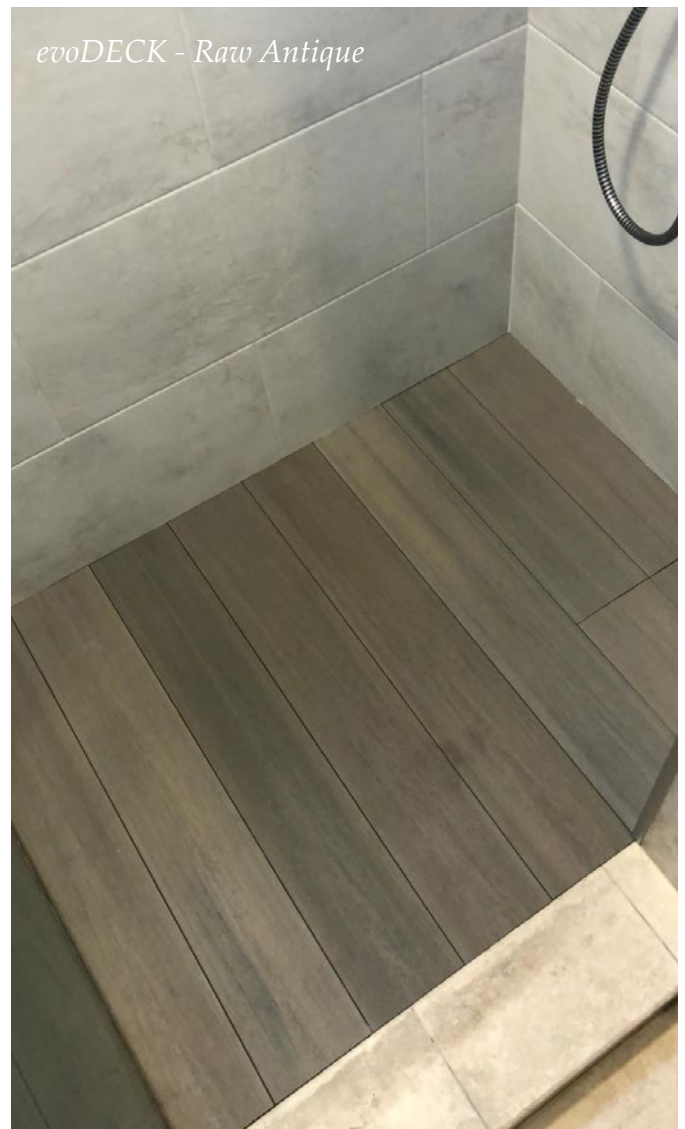

Recent Residential Projects in Singapore with evoDECK

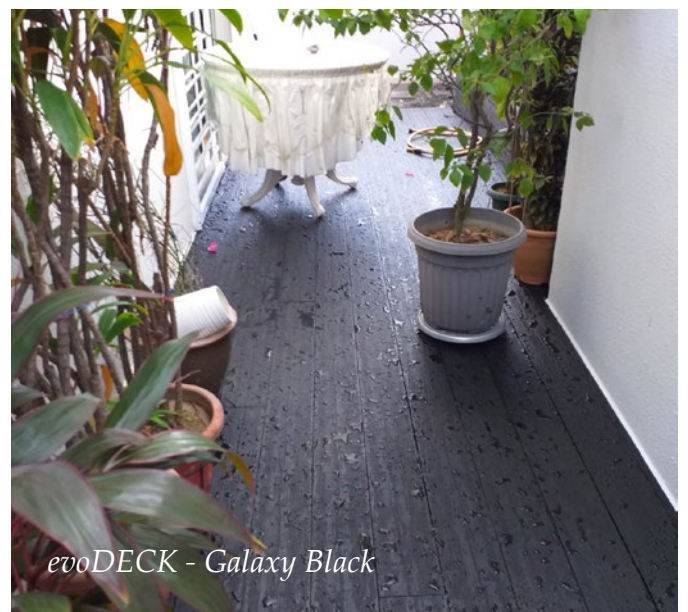
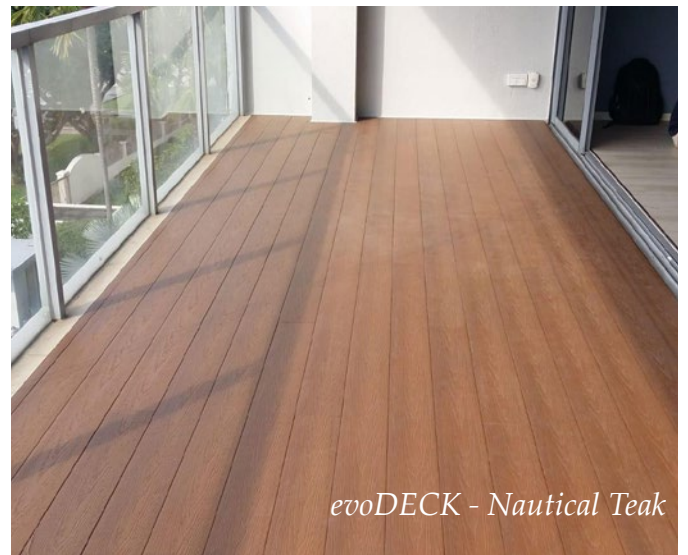

Recent Residential Projects in Singapore with evoDECK

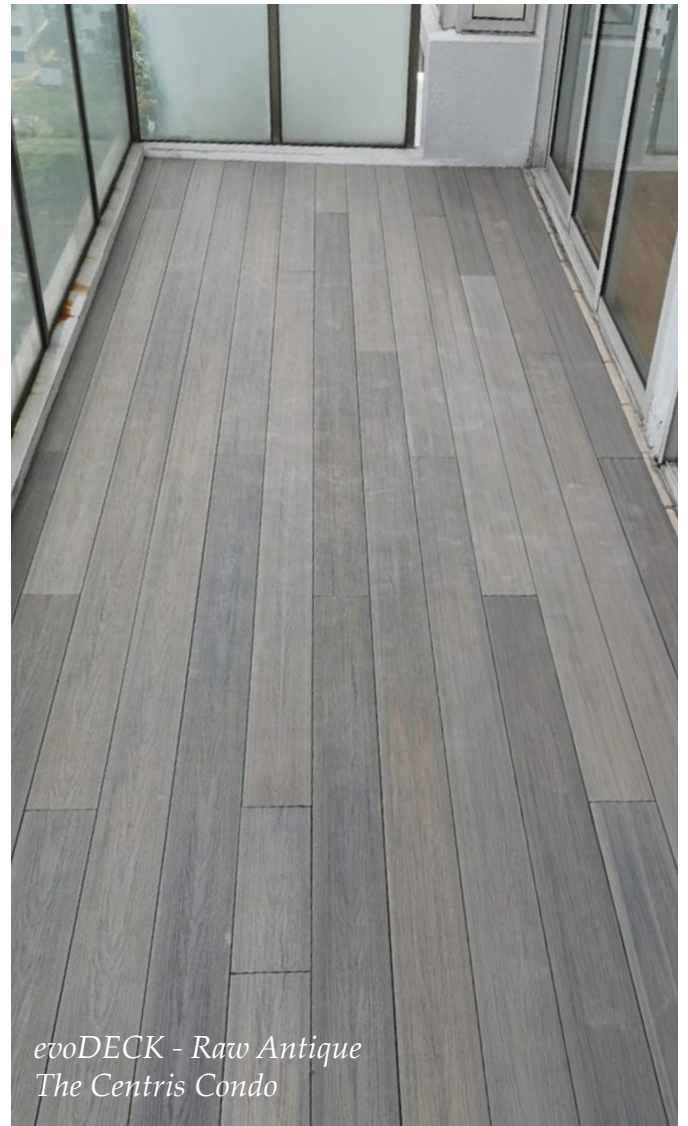
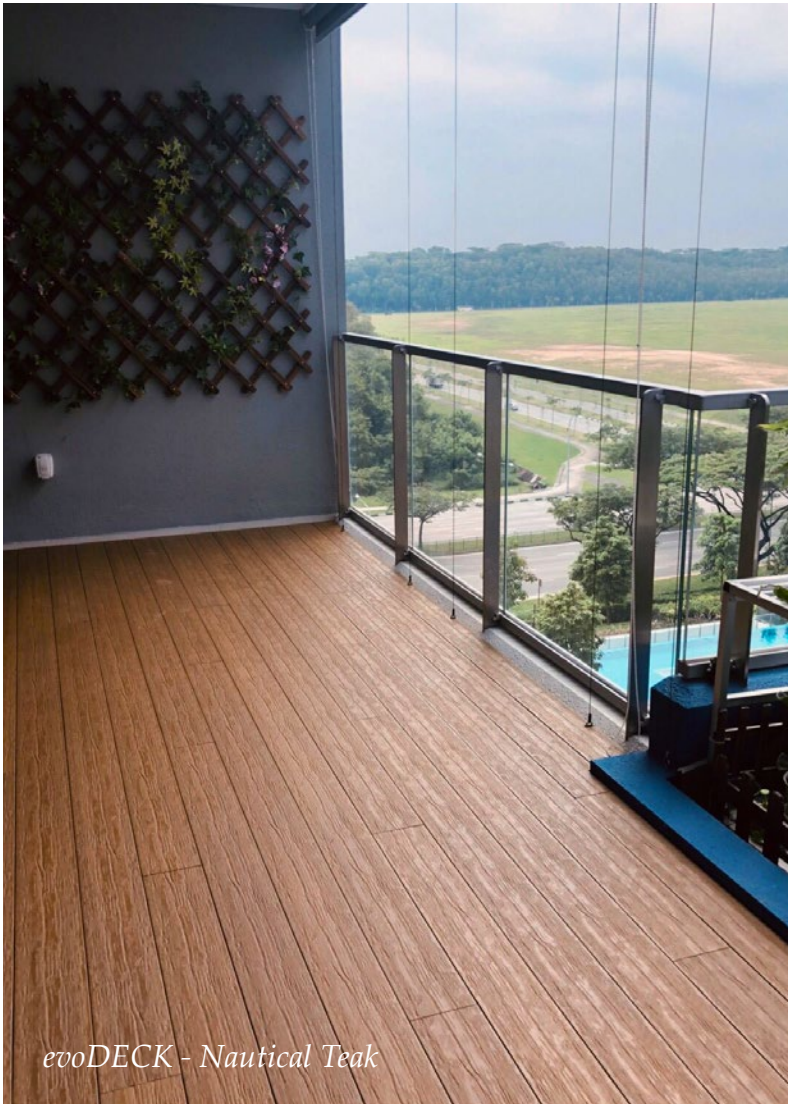

Recent Residential Projects in Singapore with evoDECK



Recent Residential Projects in Singapore
with evoDECK



Recent Residential Projects in Singapore
with evoDECK



Recent Residential Projects in Singapore with evoDECK

evoDECK as Fence - Nautical Teak

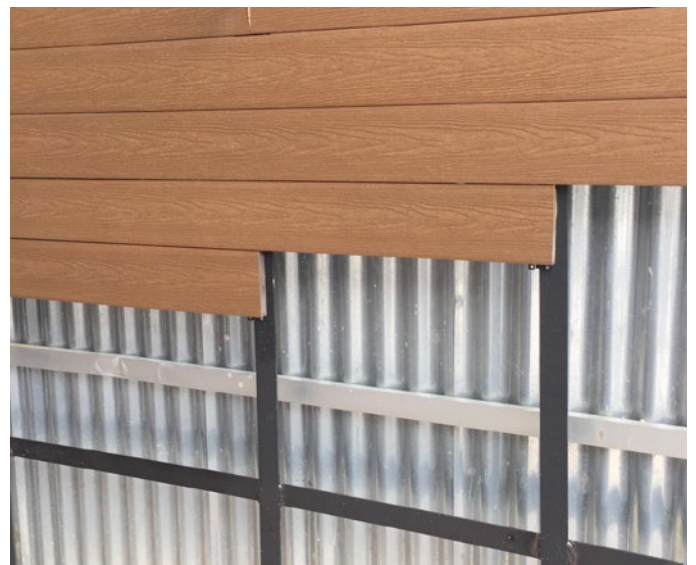
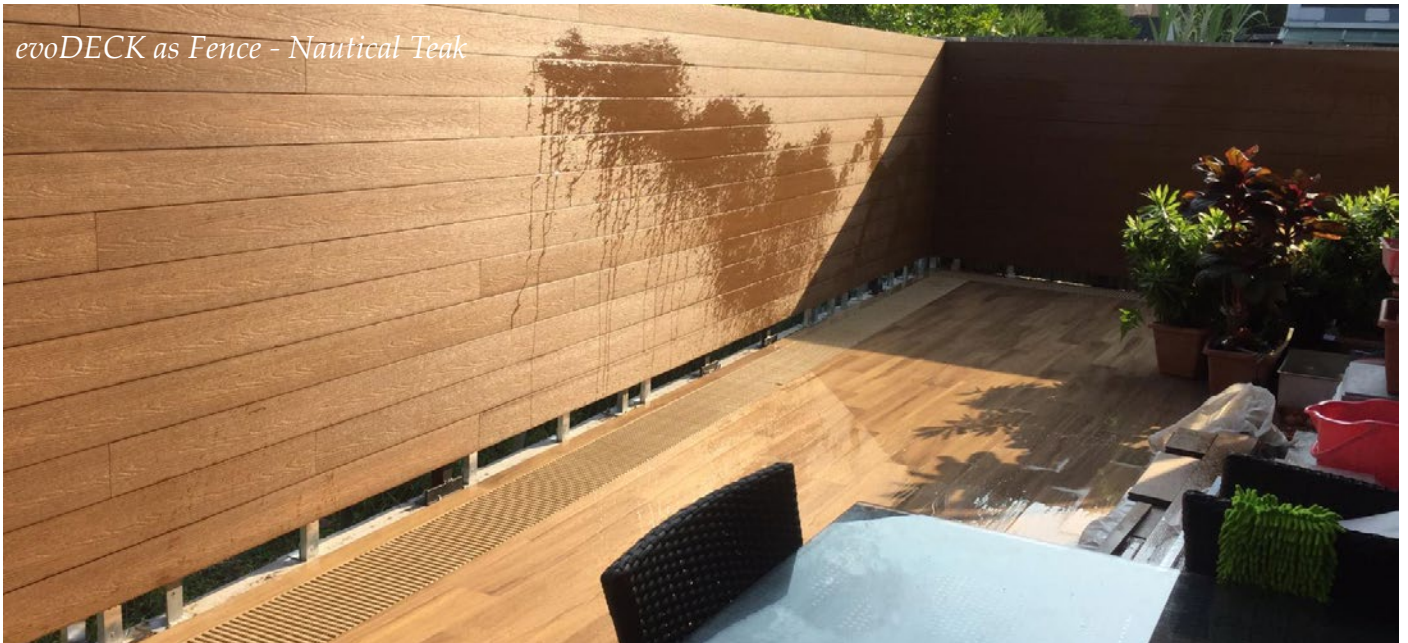

Recent Residential Projects in Singapore with evoDECK



Overseas Project with evoDECK



*Overseas Project
with evoDECK
One of the Largest Resort in Asia*

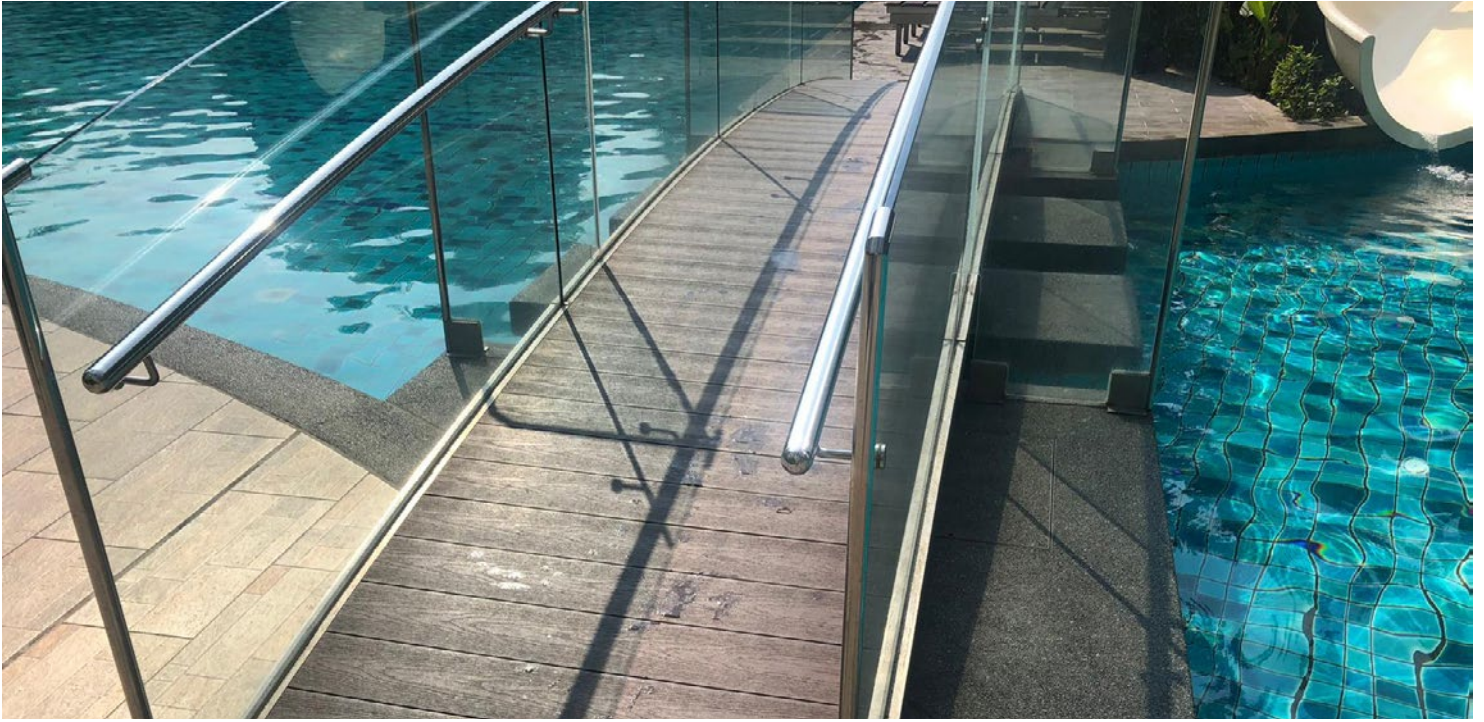

Test and Certifications

Property/Characteristic	Test Standards	Test Results
Falling Mass Impact Resistance	1) EN 15534-4:2014 <i>Section 4.5.1</i> 2) EN 15534-1:2014 <i>Section 7.1.2.1</i>	Type: Solid profile Max. Crack length (mm): No crack Max. Residual indentation (mm): 0.09
Bending strength	1) EN 15534-4:2014 <i>Section 4.5.2</i> 2) EN 15534-1:2014 <i>Annex A</i>	48.7 MPa
Modulus of elasticity		4043 MPa
Maximum load		Mean 6249N Min :5876N
Deflection at 500N		Mean: 0.92 mm Max: 0.97mm
Creep Behaviour	1) EN 15534-4:2014 <i>Section 4.5.3</i> 2) EN 15534-1:2014 <i>Section 7.4.1</i>	Span: 350 mm Mean ΔS : 2.11mm Max. ΔS : 2.17 mm Mean ΔSr : 0.55mm
Water Absorption	1) EN 15534-4:2014 <i>Section 4.5.5</i> 2) EN 15534-1:2014 <i>Section 8.3.1</i>	Mean Swelling: 0.39% in thickness 0.09% in width 0.15% in length Max. Swelling: 0.72% in thickness 0.21% in width 0.21% in length Water Absorption: Mean: 0.24% Max: 0.26%

Warranty

15-Year Limited Residential Warranty 10-Year Limited Commercial Warranty

Statement of Warranty: Evorich warrants to the original purchaser (“Purchaser”) that, for the period of times set forth in the following sentence, under normal use and service conditions, Evorich product shall be free from material defects in workmanship and materials, and shall not split, splinter, rot or suffer structural damage from termites. The term of such warranty shall be fifteen (15) years from the date of original purchase for a residential application, and ten (10) years from the date of original purchase for a commercial application.

Stain resistance and fade resistance:

evoDECK does not warrant its wood plastic composite products to be stain or fade proof. When installed, cared for and maintained properly, evoDECK products are not easy to fade and stain. However, no material is stain or fade proof, especially but not only when stains result from spilled or otherwise substances that are not properly cleaned or when the materials are exposed to years of UV exposure and the elements.

For purposes of this warranty, a “Residential Purchase” shall refer to a single-family residential homeowner and a “Commercial Purchaser” shall refer to any Purchaser other than a single-family residential family.

All warranties are subject to the exclusions, limitations and restrictions set forth below.

Obtaining Warranty Performance: If Purchaser discovers a defect in the evoDECK decking. during the Term, Purchaser must, within thirty (30) days from the discovery of the alleged defect but no later than the end of the Term, notify Evorich in writing.

Purchaser must include in this notification proof of purchase and a statement explaining the defect. Evorich may request additional information. After reviewing all information, Evorich will make a determination regarding the validity of such claim. If Evorich determines that Purchaser’s claim is valid, Evorich will replace the defective evoDECK decking in next orders. evoDECK replacement obligation allows Evorich to provide products as close in color, design and quality to the original installation as reasonably possible, in evoDECK discretion and determination. In evoDECK sole and absolute discretion, Evorich, may, at its option, elect to refund the percentage of the original purchase price listed under Recovery on the Prorated Warranty Schedule in lieu of replacing the defective product.

Prorated Limited Warranty Schedule Residential Limited Warranty

Year of Claim	1	2	3	4	5	6	7	8-9	10-11	12-13	14	15
Recovery	100%	100%	100%	100%	100%	100%	100%	80%	60%	40%	20%	10%

Commercial Limited Warranty

Year of Claim	1	2	3	4	5	6	7	8	9	10
Recovery	100%	100%	100%	100%	100%	80%	60%	40%	20%	10%

This warranty shall not cover, and Evorich shall not be responsible for, costs and expenses incurred with respect to the removal of the defective evoDECK decking or the installation of replacement material, including but not limited to, labour and freight.

The forgoing remedies are the **SOLE AND EXCLUSIVE REMEDY FOR BREACH OF ANY WARRANTY.**

Transfer of Warranty: This warranty may be transferred one (1) time, within the three (3) year period beginning from the date of original purchase by Purchaser, to a subsequent buyer of the property upon which the evoDECK decking were originally installed.

Exclusions from Warranty Coverage: Evorich does not warrant against and is not responsible for, and no implied warranty shall be deemed to cover, any product failure, product malfunction, or damage attributable to:

- (1) improper installation of the evoDECK and/or failure to abide by Evorich installation guidelines, including but not limited to improper gapping.
- (2) use of the evoDECK beyond normal residential use, or in an application not recommended by Evorich guidelines and local building codes.
- (3) movement, distortion, collapse or setting of the ground or the supporting structure on which the evoDECK are installed.
- (4) any act of God (such as flooding, hurricane, earthquake, lightning, etc.), environmental condition (such as air pollution, mould, mildew, etc.), or staining from foreign substances (such as dirt, grease, oil, etc.)
- (5) variations or changes in color of the evoDECK decking.

(6) normal weather due to exposure to sunlight, weather and atmosphere which can cause colored surfaces to, among other things, flake, chalk, or accumulate dirt or stains.

(7) improper handling, storage, abuse or neglect of the evoDECK by purchaser, the transferee or third parties. Purchaser is solely responsible for determining the effectiveness, fitness, suitability and safety of the evoDECK in connection with their use in any particular application.

Limitations:

Disclaimer of Warranties: Except for the express written warranty contained herein, Evorich makes no other warranties, guarantees or indemnities, whether express or implied, arising by law, course of dealing, usage of trade, custom or otherwise, including but not limited to the implied warranty of merchantability and implied warranty of fitness for a particular purpose, and all such other warranties, guarantees and indemnities are hereby disclaimed, overridden and exclude from this transaction.

Limitation of Remedies and Exclusion of Consequential and Incidental Damages: Evorich's liabilities are limited solely and exclusively to the obligations specifically undertaken herein, and under no circumstances will Evorich be liable or obligated for any incidental, consequential, indirect, special, punitive or any other damages of any kind whatsoever (including, but not limited to, lost profits, lost sales, loss of goodwill, use of money, use of goods, stoppage of work, or impairment of assets), whether foreseeable or unforeseeable, arising out of breach or failure of express or implied warranty, breach of contract, fraud, misrepresentation, negligence, strict liability in tort or otherwise, except and only to the extent this limitation is specifically precluded by applicable law of mandatory application. Evorich's liability with respect to defective products shall in no event exceed the replacement of such products or refund of the purchase price, as described above.

Miscellaneous: This writing is understood and intended to be final expression of the parties' agreement and is a complete and exclusive statement of the terms and conditions with respect thereto, superseding all prior agreement or representations, oral or written, and all other communication between the parties relating to the subject matter of this agreement. This warranty may not be altered or amended except in a written instruction signed by Evorich and Purchaser or permitted transferee. No agent, employee or any other party is authorized to make any warranty in addition to that made in this agreement and Evorich shall not be bound by any such statements other than those contained in this warranty.



splashDECK

splashDECK combines the beauty of wood and the practicality of plastic to provide you with a low maintenance, natural-looking solution for your balcony. splashDECK is eco-friendly and has a longer lifespan than traditional wood decking.

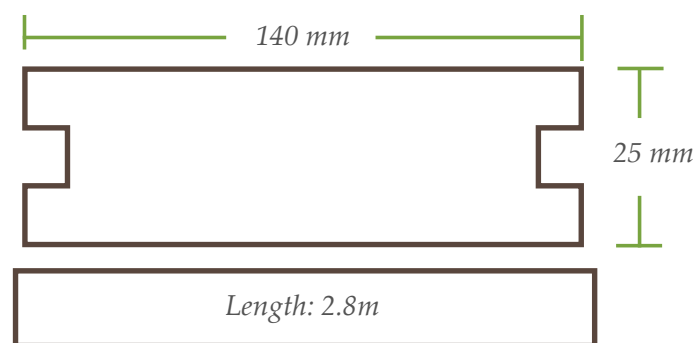

Code: SGE08
Colour: ChestNUT Oak
Width: 140mm | Length: 2.8m
Thickness: 25mm

Specifications

Dimensions:	140*25 mm
Density:	1290 kg/m ³
Breaking Load:	3064 N (3 points bending test, 400mm span)
Bending Strength:	21.43 MPa (3 points bending test, 400mm span)
Water Absorption:	Mean value: 0.1% (24 hours immersion, EN 15534-1:2004)
Linear Thermal Expansion:	41.1x10 ⁻⁶ /°C (ASTM D696:2008e1)

Features



Fire-Resistant



Waterproof



Formaldehyde Free



Eco-Friendly



Stands up to harsh weather

splashDECK Warranty

EVORICH splashDECK WPC decking comes with a 10-year limited warranty, which provides comprehensive coverage against splintering, splitting, rotting, decaying, and termite damage provided that it is used under proper usage. Our products have been tested by China's government organization, which had issued a formal test report to prove our products' quality. We can provide this test report copy if needed.

Exclusions:

Items damaged due to acts of vandalism, misuse, or improper installation is not covered. Proof of purchase (dated register receipt) is required for warranty claims. We do not reimburse for transportation or delivery costs, or compensate the individual or any outside party for assembling or disassembling the product.

Here is our recommendation:

Please try to keep this material away from heavy impact or abuse during usage. Please take care of it during transportation, installation, storage, and avoid it from falling from high places.

Test the VINYL you breathe
EVORICH
Since 2003 . . .



EVORICH R&D Production · Experience Exhibit

16 Tampines Street 92 Singapore 528873
(Behind Tampines SAFRA)



EVORICH Concept Sales Gallery

Floors · Decks · Walls · Ceilings

1 Tampines North Drive 1, #02-38 T-Space
EVORICH Block, Singapore 528559
(In Between IKEA, Giant & Courts)

EVORICH Floors · Decks · Walls Training Academy

27 Kim Chuan Terrace
Singapore 537045



EYA-Established Entrepreneur 2016

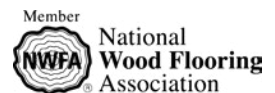

www.EVORICH.com.sg | E-mail: sales@evorich.com.sg
Hotline: (+65) 6348 7333 (16 lines) | WhatsApp: (+65) 8795 2118