

Test the VINYL you breathe
EVORICH
Since 2003...



evowalls®

INSTALLATION INSTRUCTIONS

DISCLAIMER: ACTUAL METHOD OF INSTALLATION MAY VARY
DEPENDING ON TERRITORIES OF INSTALLATION.

TABLE OF CONTENTS

INTRODUCTION.....	01
VENTILATION & SAFETY.....	01
WARRANTY	01
CARE & MAINTENANCE.....	01
INSTALLATION PLANNING.....	01
INTERIOR WALL INSTALLATION DRY.....	02
SHOWER AND TUB SURROUND INSTALLATION-WET	04

INTRODUCTION

EVORICH® evoWALLS® tiles are an innovative and unique way to dramatically change the look of a room in your home or place of business. The large format tiles have a patent pending rounded edge detail for a dramatic look and feel, and are simple to install with proper adhesive and tools.

evoWALLS® are not just for walls. They can also be installed as wainscoting, on interior decorative columns, kitchen backsplashes, islands & peninsulas, fireplace surrounds and much more.

Cutting Inside and Outside 90 degree corners:

- Use a high speed palm router or utility knife to form outside 90° corners with no visible seams.
- Use a utility knife to cut the cellular backing material to form inside 90° corners.

Corner angles can range from 0° to 90°, thus eliminating additional trim pieces and creating an amazing clean and finished look.

evoWALLS® can be installed in dry or wet applications. Please follow recommended adhesives for these dry and wet installations as shown on page 2.

VENTILATION & SAFETY

PLEASE READ THIS ENTIRE MANUAL PRIOR TO INSTALLATION.

- Be sure the work site has proper ventilation during installation.
- The use of NIOSH dust respirator is recommended during the cutting of tiles with power tools to prevent inhalation of NIOSH dust.
- Wear safety glasses.

WARRANTY

3 YEARS RESIDENTIAL LIMITED WARRANTY

CARE & MAINTENANCE

DRY

- Use a non-abrasive all purpose cleaner like Windex® with paper towels or a clean cloth. Or, vacuum with a soft bristle brush attachment.
- Do NOT use any type of cleaning product containing bleach, abrasive cleaner or strong chemical detergent.
- Use door stops, knob protectors, or door knob covers to prevent damage from doors banging against the wall.

WET

- Use a non-abrasive all-purpose cleaner like Windex® with paper towels or a clean cloth. Or, vacuum with a soft bristle brush attachment.
- Do NOT use any type of cleaning product containing bleach, abrasive cleaner or strong chemical detergent.
- Use door stops, knob protectors, or door knob covers to prevent damage from doors banging against the wall.
- Every 6 months, check all silicone adhesive grout lines and repair if necessary.

- Vinyl tiles can show signs of fading in some applications. To bring tiles back to original sheen, vinyl floor polish can be applied. Follow floor polish manufacturer's installation instructions.

INSTALLATION PLANNING

CONDITION THE PRODUCT PRIOR TO INSTALLATION

- You must acclimate the product in the room of installation. Store the product horizontally at a temperature between 65°F to 85°F (18-30°C) for a minimum of 48 hours. Do not remove the tiles from the cartons during this process. Maintain this temperature during and after the installation.
- WARNINGS:** evoWALLS® are intended for interior installations only and in temperature controlled environments. Any exterior usage including seasonal porches will void the warranty.

TILES NEEDED TO COMPLETE YOUR PROJECT

- Measure in inches the height and width of the walls to be installed. Multiply those two numbers and divide by 144 to give you the square footage of the walls. Most installations will require a 10% waste factor for cuts and mistakes. However, this may vary depending upon the layout of the room. If you are installing on diagonally, factor in for 25% waste.
- EXAMPLE:** For a normal staggered installation, an 8'H x 10'L wall = 80 sq. ft. + 10% = 88 sq. ft. to purchase. See the chart below to find out how many cartons you need.

DYE LOTS

- evoWALLS® do have specific dye lots or RUN #'s. The Run # is located on the ends of the cartons. Installations are preferably done with one run #. However, if you do have more than one run #, simply mix and match the different run #'s by installing from several different cartons from different run #'s at the same time.

TOOLS REQUIRED

- Tape Measure
- Pencil
- Chalk line or laser level
- Utility Knife
- Square
- Straight Edge
- Hand Roller
- Trowel - for spreading adhesive only
 - For non-porous surface, use trowel notch 1/32" x 1/16" x 1/32"
 - For porous surface, use fine notch trowel or 1/16" V-notch trowel
- Clean rag
- Blue painters tape
- Drop cloth / plastic sheeting / paper for masking adhesives
- NIOSH dust respirator
- Safety glasses
- Hair dryer - used for the bending method of outside and inside 90° corners
- Optional power tools
 - High speed palm router (see page 4 for "V" grooving instructions and additional tools required.)
 - Heat gun (can be used in place of hair dryer. However, please be cautious not to overheat Verlux LWT too quickly. Heat slowly. Keep the heat gun minimum 12" away from tiles)

INSTALLATION PLANNING (CONTINUED)

DRY WALL INSTALLATIONS

APPROVED SUBSTRATES FOR DRY INSTALLATIONS

- Plywood (must be A.P.A approved with a minimum grade of "BB" or "CC")
- Sheetrock / drywall / green board - MUST BE PRIMED or PAINTED with latex paint.
- Ceramic tile
- Wood paneling
- Fiberglass / plastics
- Beadboard / tile board
- Vinyl / PVC
- Concrete - (must be smooth, flat, dry and sealed)
- Hardibacker
- Cement board
- Glass

NON-APPROVED SUBSTRATES FOR DRY INSTALLATIONS

- Brick
- Cinder block
- Carpets & textiles
- Luan, Particle Board, OSB

APPROVED ADHESIVES FOR DRY INSTALLATIONS

NOTE: Adhesive must be maintained at 68°F (20°C) for a period of 36 hours prior to use.

- TopTile™ #6518 Adhesive (trowel)
- TopTile™ Wall Tile Adhesive (spray)
- Omni Grip Maximum Strength Adhesive
- Liquid Nails Heavy Duty Construction Adhesive (Part #LN-903)

WET WALL INSTALLATIONS

APPROVED SUBSTRATES FOR WET INSTALLATIONS

- Existing Ceramic tile
- HardieBacker®
- WonderBoard®

APPROVED ADHESIVES FOR WET INSTALLATIONS

NOTE: Adhesive must be maintained at 68°F (20°C) for a period of 36 hours prior to use.

- OmniGrip® Max Strength Adhesive
- Spray-Lock Panel Adhesive

APPROVED MOISTURE BARRIERS FOR WET INSTALLATIONS

- Use a paintable waterproof membrane.

APPROVED GROUT AND CAULK FOR WET INSTALLATIONS

- Simple Grout® Premixed Acrylic Grout (Custom® Building Products). For use when 1/8" spacers are used.
- Polyblend NON-sanded caulk (Custom® Building Products). For use when Verlux panels are butted together with tight seams (no spacers).

INTERIOR WALL INSTALLATION - DRY

SURFACE PREPARATION

- Surface must be smooth, dry, flat, free of dust and other foreign matter. Remove loose paint, wallpaper, old adhesive residue, wax or any other substances that may interfere with the bonding of the adhesive.

- Voids or deviations of 1/4" (5mm) need to be leveled with spackle/joint compound. Follow spackle/joint compound instructions to allow for proper drying time.
- For installations over new drywall you will need to "mud" the seams where new drywall sheets join together. Drywall sheets are tapered along the long ends, and this needs to be filled for a smooth, flush substrate. You do not need to tape these seams.
- Remove all electrical plates, vents, and fixtures attached to the wall. Note: It may be necessary to purchase longer screws when reattaching electric plates or fixtures after your evoWALLS™ have been installed.

PROPER INSTALLATION METHODS

- When cutting tiles for length or height, it is recommended to place the cut edge into wall corners or along the ceiling or floor. This is to hide the exposed cut edge where the factory rounded-over the beveled edge detail or was removed. Never install a cut edge tile to a factory rounded-over beveled edge.
- If you plan to space the tiles for grouted installation, a maximum of 1/8" gap is allowed. See the Shower and Tub Surround Wet installation section step 9 on page 5 for more information.
- evoWALLS™ can be "V" grooved for outside 90° corners. To accomplish this you must have the following tools which are readily available at most local home centers or hardware stores (See page 4).
 - High speed palm router with a square-based attachment for running along clamped cutting guide/ fence. This ensures straight "V" groove cuts. A micro dial on the palm router is recommended and will make for a more accurate depth in the "V" groove cuts. Use a 90° 1/2" diameter "V" grooving bit.
- Tiles can be installed in many different patterns. Here are a few examples:

1. Brick Pattern

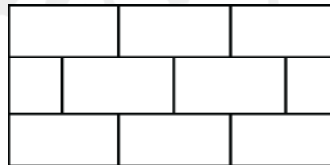

2. Diagonal Pattern

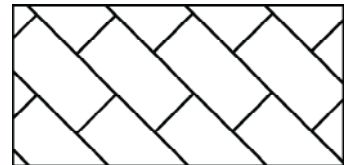

3. Herringbone Pattern



4. In-Line Pattern

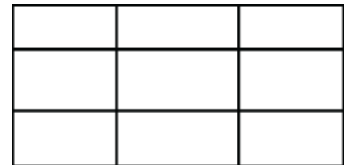

NOTE: When installing in-line pattern #4, it should be noted that a "pinhole" effect may occur where 4 tiles intersect. This is possible due to the soft nature of your evoWALLS™. Take caution and be careful not to damage tile corners prior to installation. If the "pinhole" effect is noticed at any given intersection, it is advised to use a very small amount of color matching silicone adhesive to fill the "pinholes".

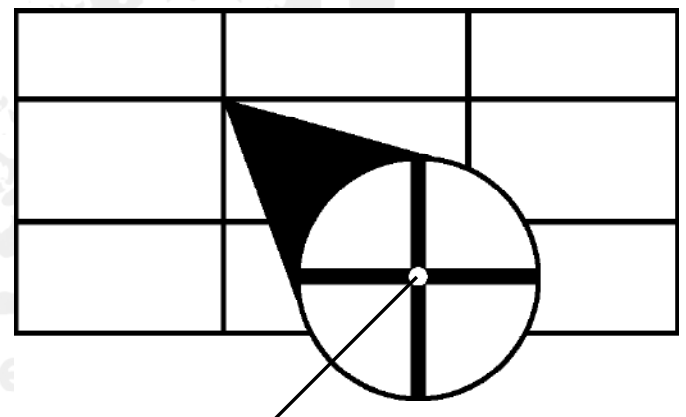

Fill the pinhole with colour matching silicone adhesive where needed.

1 MEASUREMENT AND LAYOUT

NOTE: The first row tiles is the most important and should be taken care of for a balanced appearance. The first row should start at the bottom of the wall and work your way up to the ceiling.

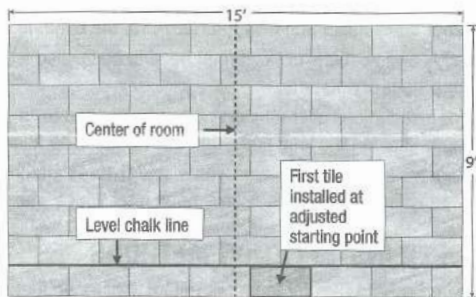

- Find the center point of the wall by measuring the wall and dividing by 2.
- Mark the wall at the bottom, center, and top of the wall at the center point and snap a chalk line or draw a straight line. The wall is now divided into two equal parts.
- Depending upon the length of the tiles you are installing or the direction of the tiles you are installing, divide the length of the room by the length of the tile to see how many full tiles are needed to complete a row.
- If at the end of the first row you have a tile that is less than 6", you can shift the center line accordingly. Do the same thing for the height of the wall to see if you need to cut the first row of tiles lengthwise.
- All borders will now be at least as wide as 1/2 the tile and will be easier to cut as well as providing the best visual appearance.
- As your floor may not be level, it is recommended that you snap a level chalk line on the top of your first row of tiles to ensure your entire first row is level.

2 APPLYING SPRAY ADHESIVE

NOTE: Surface must be dry and free from material that may deter adhesion.

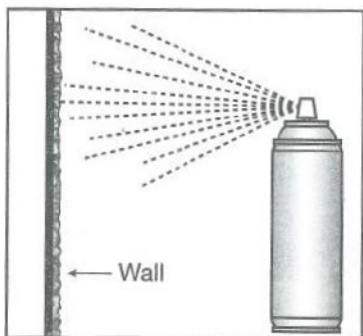

- Mask the area of installation with painters tape, paper, plastic sheeting and/or use a spray shield to protect from overspraying the adhesive. ALWAYS follow the manufacturer's instructions on adhesive container when applying the adhesive.
- Apply adhesive to the surface of installation. Follow the manufacturer's guidelines on the adhesive container for application, flash time, open time, and drying time.
- When spraying on the wall adhesive, be sure to pay special attention to the proper coverage where tiles end or meet another tile to ensure the four corners and outer edges of the tiles are well-bonded to the wall.

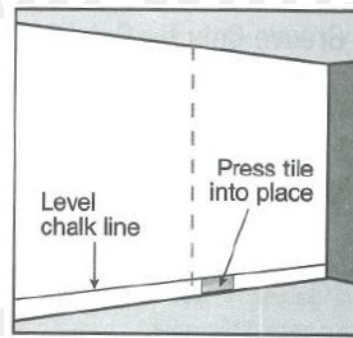

- Place your first evoWALLS® tile into the desired location and immediately press into place with your hands. Roll with a hand roller to ensure complete bonding of the adhesive to the back of the tile.
- As stated in Step 1, snap a level chalk line along the top edge of this first tile to ensure a level first row.
- You do not need to hand roll each tile after placement. Only the first tile needs to be rolled to start. However, it is recommended that after you place approximately 10 full tiles, stop installing and hand roll these tiles before continuing installation. Continue this method for the remainder of the installation. After full installation and completion, hand roll entire wall one last time.

4 APPLY THE FIRST TILE

- When cutting tiles for length or width, use a straight edge and sharp utility knife. Cut through the cellular backing of the tile with your knife. Make several passes with your knife and then snap. After snapping the tile which is now 99.9% cut, leaving only the decor film and wear layer to be cut. Run your utility knife along the decor film and wear layer to complete the cut.

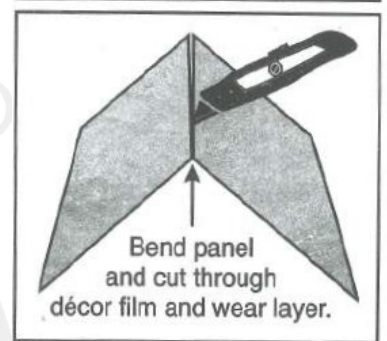
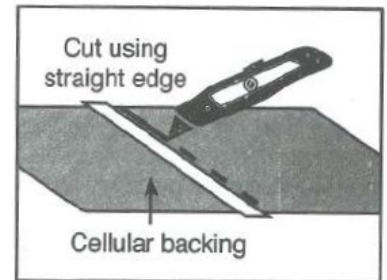

NOTE: When coming to the end of a wall, window, or door casing, you can use colour-matched water-based silicone caulk to finish off the installation, or trim the molding (painted or stained) to desired finish in order to hide the cut end of the tiles.

5 "V" GROOVE CUTS FOR OUTSIDE 90° CORNERS

VERY IMPORTANT : Do not cut through the decor film.

TOOLS REQUIRED TO PERFORM THIS STEP

- High-speed palm router with square flat base attachment and micro adjust dial
- 90° 1/2" diameter "V" grooving bit
- Clamping fence / cutting guide
- Hair dryer or heat gun

- To make a "V" Groove cut for outside 90° corners you must first mark the tile on the back where the cut will be made.
- Measure the distance at which point the tile should bend and transfer the measurement with a straight edge and pencil onto the back of the wall tile.
- You will need to set your depth using the "micro adjust dial" on your high-speed palm router. Correct depth should have the point of the "V" groove bit tip just touching the grey mid-layer of the tile just behind printed film.
- After making the "V" Groove cut, before bending the tile, use a hair dryer to heat up the beveled cut to make it bend easily.

Wall Panel Layers



Outside 90° Corners

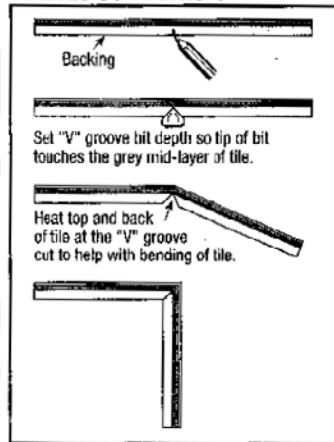

NOTE: Be cautious when using a heat gun as the extreme fast heating would damage the tile. Go slowly and keep the heat gun tip a minimum of 12" from the tile.

6 INSIDE 90° CUTS

VERY IMPORTANT : Do not cut through the decor film.

Inside 90° cuts are simply done by cutting through the cellular backing of the tile with your utility knife and carefully bending the tile at that point. Using the hair dryer on the back of the tile first will allow the tile to bend easier.

NOTE: WHEN MEASURING WHERE TO MARK THE TILE FOR CUTTING for an inside 90° corner, you need to deduct the thickness of the tile (4.8mm or 0.19") because the length of the tile after bending will increase by the thickness of the tile.

Inside 90° Cuts

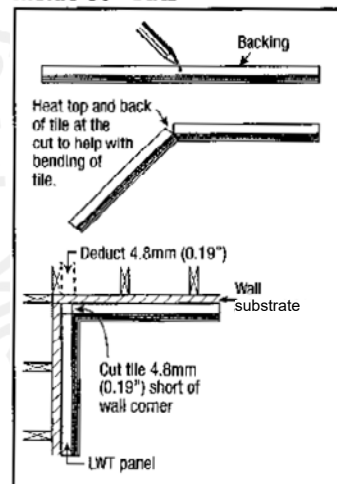

SURFACE PREPARATION & INSTALLATION

NOTE: Always read all manufacturers' installation or application instructions before use. Be sure the work area is well-ventilated and temperature-controlled.

- When installing evoWALLS® in an existing shower or tub surround over existing ceramic tiles, we recommend a light sanding of the existing tiles first. Be sure to wipe the surface clean after sanding with damp cloth and allow it to dry thoroughly before proceeding with installation. This will provide a better surface for the adhesive to hold the tiles in place.
- For new construction or remodels down to the studs, use a cement backer board like WonderBoard® or HardieBacker®. **TOOLS REQUIRED** for cement board installation: Scoring knife or utility knife for cutting, straight edge, hammer, trowel, sponge, drill w/ screwdriver bit, cement board screws 1 1/4", and alkali-resistant mud compound.
- SAFETY TIP:** NEVER cut cement board indoors with high speed power tools as it may cause silica fibers to be released into the air, which can be hazardous to your health. Use carbide tipped scoring knife or a utility knife. NEVER use a damp cloth/sponge or a HEPA vacuum during cleanup or dry sweeping.

1 FRAMING THE SHOWER OR TUB SURROUND

- Framing studs of shower or tub surround should be 16" on center and level with no warping or twisting of studs.

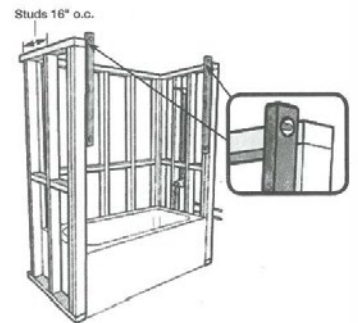

2 LAYOUT OF PLUMBING

- Ensure allowance is made for backer board material and evoWALLS® when laying out plumbing.

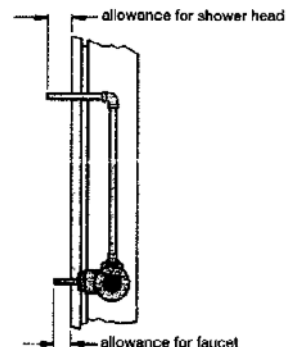

3 INSTALLING BACKER BOARD MATERIAL

- Installation requires 1/2" minimum cement backer board material.
- Use backer board manufacturer recommended screws and follow the manufacturer installation instructions.
- Wipe cement board with damp cloth to remove any excess dust.
- Mud all seams until smooth.

NOTE: Plumbing hardware could be located on the left, right or center wall. Be sure to dry fit the backer board material prior to installation. These installation instructions show right tub surround wall plumbing, your installation may differ.

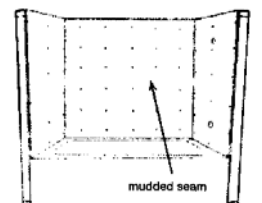
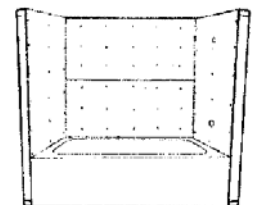

SHOWER AND TUB SURROUND INSTALLATION - WET (CONTINUED)

4 WATERPROOFING / MASK OFF AREA

- Mask off shower / tub surround with drop cloth / plastic / paper with painters tape to protect dripping of waterproofing material and adhesive.
- Apply Latex Waterproofing Membrane with a paint roller or brush.
- Follow manufacturer's installation instructions for proper application and dry time.

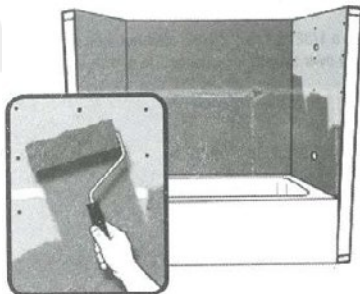

5 MEASUREMENTS AND LAYOUTS

- Find your starting point for the first evoWALLS® to be installed.
- Refer to page 7 Step 1. Use this same method.

NOTE: These instructions show evoWALLS® being installed butted tight against each other. You can also use 1/8" spacers to leave a gap in between the tiles and grout the tiles using an acrylic premixed grout.

Example Layouts shown for a 30" x 60" Tub Surround

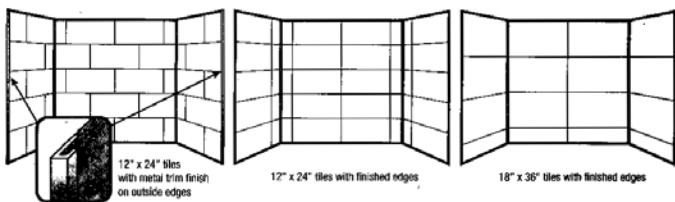

6 APPLYING ADHESIVE WITH A TROWEL

- Using a 1/32" x 1/16" x 1/32" fine notched trowel, spread adhesive evenly over area of installation. Do one wall at a time.

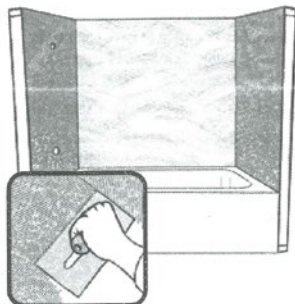

7 APPLYING THE FIRST TILE

- Working from the bottom center of the back 60" wall, install the tiles by firmly pressing the tile into the adhesive. Continue until all tiles are installed. Be sure to place cut edge of the tiles in the corners or at the end of the side walls.
- Continue laying tiles on back wall until completed.

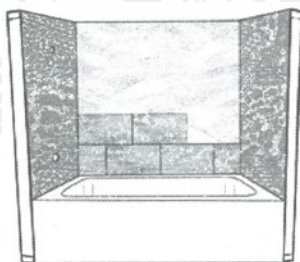

NOTE: Depending on your tile layout, all the cut edges of the tiles should be placed into 90° corners or onto outside of side walls.

8 DRYING TIME

- Allow 24-72 hours for adhesive to dry before grouting and caulking the seams.
- READ MANUFACTURER'S GUIDELINES FOR DRY TIME.

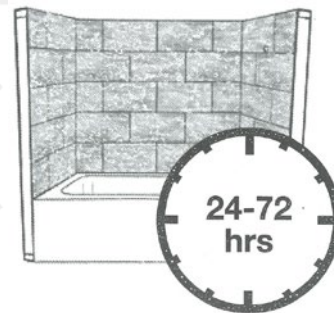

9 APPLYING CAULK AND GROUT

- Use a colour matching water-based silicone caulk on the corners of the walls, the bottom edge where it meets the tub (or shower), the top edge, and all field seams.
- If you have opted to use 1/8" spacers to grout your tiles, then apply acrylic premixed grout in the field seams.
- Recommended for use: Custom Building Products Polyblend matching grout silicone.

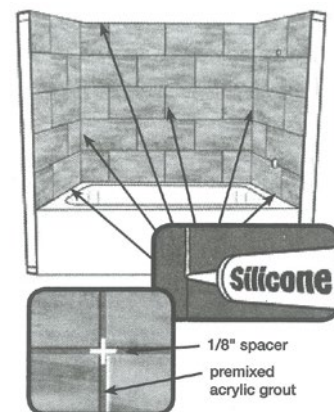

NOTE: Also run a small bead of silicone between each tile.

10 APPLYING EDGE TRIM

- OPTIONAL: Install a metal edge to finish off the two end walls.
- The metal edge is shaped like an "L" with the long side sitting beneath the last row of evoWALLS® and the short side coming up to sit next to and overlap the edge of the tile. This hides the edge of the tile and creates a finished, subtle transition. Metal strips are available in a wide range of finishes, as well as a few different profiles. You can also use the colour matched premixed grout for the two end walls. Allow 24 hours to dry before installing a shower door. Be sure to follow shower door manufacturer's instructions when installing the door.
- Install plumbing fixtures and fittings.

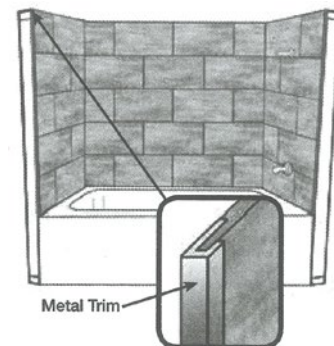

Test the VINYL you breathe[®]
EVORICH[®]
 Since 2003 . . .



Evorich Manufacturing Pte Ltd



A ROTARY SINGAPORE ASME AWARD
 EYA-Established Entrepreneur 2016



Represented Singapore in
 ASEAN-Japan
 Young Entrepreneur Forum



Singapore Manufacturer



Winner, SPBA - Established Brands



w: www.EVORICH.com.sg | e: sales@evorich.com.sg
 T: +65 6348 7333 (16 lines) | +65 8795 2118 WhatsApp | F: +65 6342 9331

EVORICH R&D & Production · Experience Exhibit (Cheques Receiving Centre):
 16 Tampines Street 92 Singapore 528873

EVORICH Concept Sales Gallery
 Floors · Decks · Walls · Ceilings:
 1 Tampines North Drive 1, #02-38 T-Space EVORICH Block, Singapore 528559
 (In between IKEA, Giant & Courts)

EVORICH Floors · Decks · Walls Training Academy:
 27 Kim Chuan Terrace Singapore 537045

EVORICH WhatsApp



SAVOUR Me!